

600 Series Patio Doors

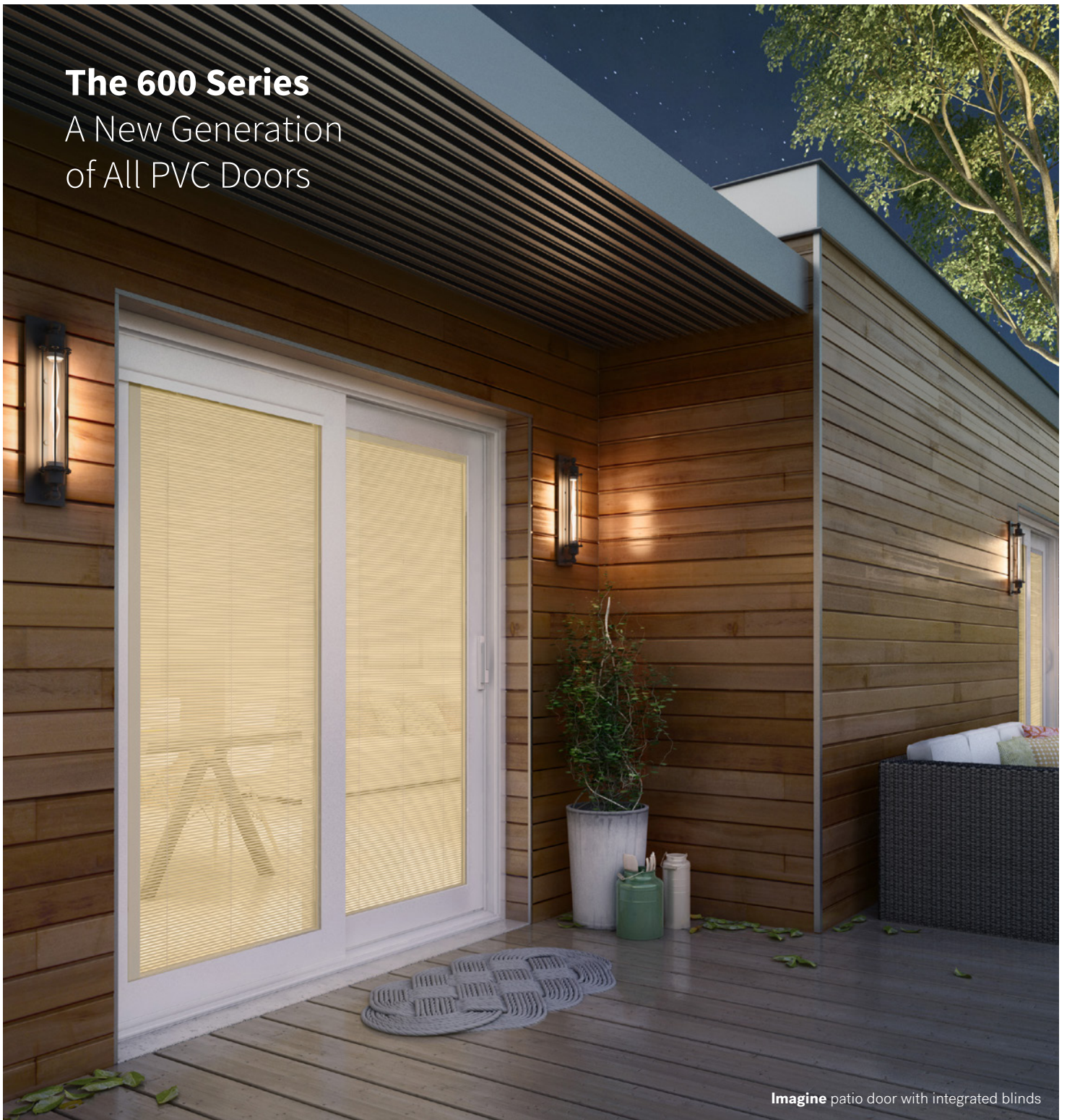

The 600 Series

A New Generation
of All PVC Doors



Imagine patio door with integrated blinds

The 600 series patio doors are the result of 35 years of experience at Novatech. Beyond their **sleek contemporary style**, these doors feature a unique and **innovative wood insert in the jambs** for added strength and easy installation, a **broad host of options** to suit any type of construction and a design that offers **superior energy efficiency**.



The **630** door meets the requirements of the **Energy Star** program



Enjoy the View With
the **630** Patio Door

The 630 patio door matches any architectural style. Its **narrow sash** and **large glass surface** let you make the most of the outside view.



The **Imagine** Patio Door — Elegant and Stylish

Imagine provides all the charm of a **garden door** without the drawbacks of a hinged door. Its **wide sash** and styling options let you customize your door to be the focal point of the room — both architectural and practical.



630

PVC

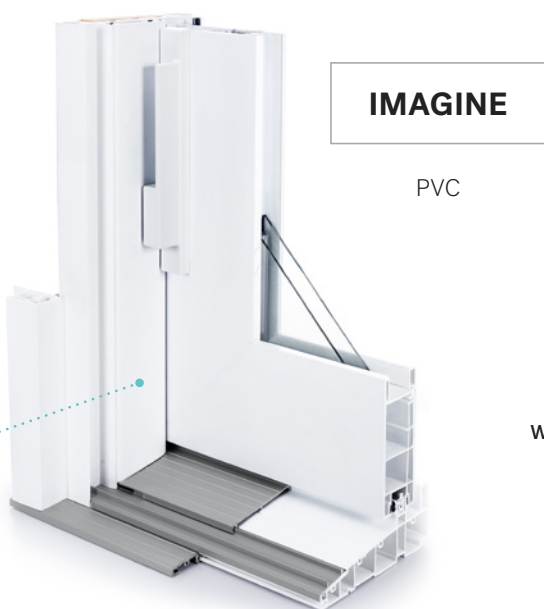

IMAGINE

PVC



Wood reinforcements in the jamb

Unique to the 600 series, a pine insert in the PVC jambs provide additional strength and a sturdy wood backing for easy installation.

Features

Frame

- Multi-chambered PVC frame with wood inserts in side jambs
- Frame depths from 5 3/4" to 11 3/4"
- Quick draining sill sloped at 9°

A Aluminum sill cover
Improved sill durability and superior finish

B PVC cavity filler cap

Sash

- Steel reinforcements in the vertical stiles
- 45° fusion welded corners and interior glazing stops
- Wide *garden door* style sash

Insulated Glass

- Tempered Low E glass with low-conductive spacer

Hardware

- 9600** mortise handle **NEW**
- Look** contemporary style mortise handle **NEW**
- View** contemporary style mortise handle **NEW**

	630	IMAGINE
Frame		
Multi-chambered PVC frame with wood inserts in side jambs	✓	✓
Frame depths from 5 3/4" to 11 3/4"	✓	✓
Quick draining sill sloped at 9°	✓	✓
A Aluminum sill cover Improved sill durability and superior finish	Option	✓
B PVC cavity filler cap		✓
Sash		
Steel reinforcements in the vertical stiles	✓	✓
45° fusion welded corners and interior glazing stops		✓
Wide <i>garden door</i> style sash		✓
Insulated Glass		
Tempered Low E glass with low-conductive spacer	✓	✓
Hardware		
9600 mortise handle NEW	✓	
Look contemporary style mortise handle NEW		✓
View contemporary style mortise handle NEW		Option

Options

Configurations

✕ OPERATING PANEL
 ○ FIXED PANEL
 (OUTSIDE VIEW)



630

5'	6'	8'	9'	9' & 12'	10' & 12'
59½" × 79½"	71½" × 79½"	95½" × 79½"	104⅝" × 79½"	107¼" × 79½"	116½" × 79½"
58½" × 81"	70½" × 81"	94½" × 81"	103¼" × 81"	105⅞" × 81"	114½" × 81"
				141¾" × 81"	140⅞" × 79½"
				9' XOO or OOX door available on demand	138⅞" × 81"

IMAGINE

5'	6'	8'	9'	9' & 12'	10' & 12'
59½" × 79½"	71½" × 79½"	95½" × 79½"	104" × 79½"	107⅞" × 79½"	116½" × 79½"
58½" × 81"	70½" × 81"	94½" × 81"	102⅞" × 81"	106⅞" × 81"	114½" × 81"
					140⅞" × 79½"
					138⅞" × 81"

Hardware

630



9600 Handle (Standard for 630)
 Zinc or stainless steel double-point mortise option available
 Key lock option available.

White

Imagine



Look Handle (Standard for Imagine)
 Zinc or stainless steel double-point mortise option available
 Key lock option available.

White



View Handle (Option for Imagine)
 Zinc or stainless steel double-point mortise option available
 Key lock option available.

White
 Oil Rubbed Bronze (Paint)
 Satin Nickel

Colors

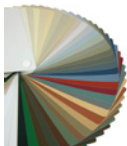

More than 100 colours available.
 Custom colours on demand.

Integrated Blinds

(Imagine only)



Integrated blinds are a great way to let light in during the day while ensuring absolute privacy at any moment. Easy to operate with two discreet buttons. Because the blinds are between the glass, they are virtually maintenance free. Available in two colors to match any decor.



White



Satin grey

Decorative Options



Dividers

Rectangular 2", 1 × 3 or 1 × 4



Grids

Rectangular 5/8", 3 × 6



Hanging Grids

Rectangular 5/8" or 1", 3 × 1

Security



Double-point mortise lock
(Option shown with Look handle)



Three-position foot lock option
(Option only available in white)



Security bar option
(Option only available in white)

Other Options

Configuration

- Transoms
- Sidelites
- Aluminum sill cover (Standard for Imagine)

Glass options

- Low E glass
- Triple glass (Imagine seulement)
- Tinted grey or bronze glass

Security options

- Reinforced screen

Performance Options

- Sill Towner Riser for improved water resistance

Installation options

- Wood extension on 3 or 4 sides with interior PVC cladding
- PVC Brick mould and aluminum sill extension
- PVC Drywall moulding
- Nail fin

Performance

	630	IMAGINE
Air leakage resistance	A3	A3
Water penetration resistance	B3 / 330 Pa – B4 / 400 Pa with Sill Tower Riser (Option)	B4 / 400 Pa
Wind resistance	C3	C3
Operating force	E3	E3
Forced-entry resistance	F10	F2
Uniform load structural test	DP-45	DP-45
Global	PG-R45	PG-R45
Laboratory tested Harmonized standards – AAMA / WDMA / CSA101 / I.S.2 / A440-08 Canadian standards CAN/CGSB-82.1-M89	Référence porte 71 ½" × 81"	Référence porte 71 ½" × 81 ½"

	630		IMAGINE	
	RE	U Value	RE	U Value
Insulated Glass				
Standard Double-pane — Low E on face 3	35	1.70 	29	1.76
Option Double-pane — Low E on face 2	31	1.76	28	1.70
Option Triple-pane — Low E on face 5	—	—	33	1.48

Warranty



20 years limited warranty on white PVC and Aluminum extrusions and sealed units (Residential applications). 10 years limited warranty for the paint on PVC or Aluminum and on integrated blinds. 5 years limited warranty on hardware. 1 year limited warranty starting on the date of delivery, applied to all manufacturing defects of the product as well as to labor and transportation costs. Consult your retailer for more information.



500 Series Patio Doors



The 500 Series

The Reference in
PVC Patio Doors



550 patio door with transoms and
View handle in oil rubbed broze (paint) finish

The 550 door offers **exceptional energy efficiency** that meets the **Energy Star** standard while the Element door features **superior durability** and an **outstanding finish** thanks to its aluminum cladding. Ideal for both renovation and new construction projects, their wide choice of sizes and configurations are suitable for any type of building.



The **550** door meets the requirements of the **Energy Star** program



The **550** door:
Simply good looking

With its **clean profile** and **elegant handle**, the **550** door offers a **modern look** that blends in with your decor. It will make you appreciate your living space more, inside and out, thanks to the light provided by its **large glazed surface**. This high quality door is a sure value.



The **Élement** door meets the requirements of the **Energy Star** program with the Triple-pane glass option



Élement patio door with integrated blinds and **View** handle in oil rubbed broze (paint) finish

Add color with the **ELEMENT** door

The advantages of a patio door with **aluminum cladding** are undeniable: **enhanced look, strength** and **durability**. With its **6 trendy colors**, Element allows you to personalize your door. Let your creativity run free to create the incredible decor you dream of.

Six colors of exterior aluminium cladding **at no additional cost!**
Standard white PVC interior.



White
(Blue tint)



White
(Cream tint)



Clear
anodized



Charcoal



Commercial
Brown



Black



550

Wood Frame / PVC



ELEMENT

Hybrid
Wood Frame / PVC / Aluminum

Features

	550	ELEMENT
Frame		
Aluminium-clad wood and PVC frame		✓
Frame depths from 5 ½" to 11 ¾"	✓	✓
Quick draining sill sloped at 9°	✓	✓
A Cavity filler cap	PVC — Option	Aluminium outside — Included PVC inside — Option
B Aluminum sill cover	Option	✓
Give your 550 door a superior look and finish with these two options.		
Sash		
Aluminum clad sash		✓
45° fusion welded corners and interior glazing stops	✓	✓
Steel reinforcements in the vertical stiles	✓	✓
Color		
Six standard colors of aluminum cladding		✓
Insulated Glass		
Tempered Low E glass with low-conductive spacer	✓	✓
Hardware		
Look contemporary style mortise handle ^{NEW}	✓	✓
View contemporary style mortise handle ^{NEW}	Option	Option

Options

Configurations

OPERATING PANEL FIXED PANEL (OUTSIDE VIEW)

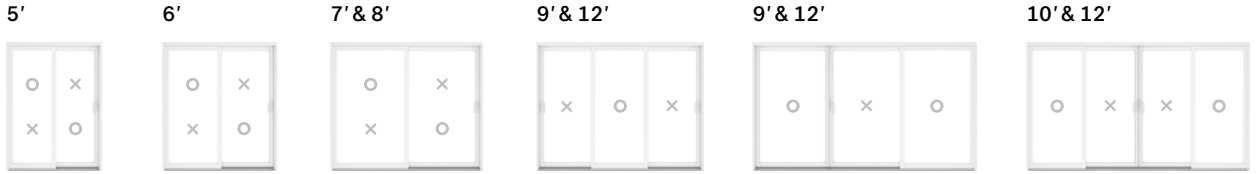

550

59 1/2" x 79 1/2"	71 1/2" x 79 1/2"	95 1/2" x 79 1/2"	105" x 79 1/2"	107 3/16" x 79 1/2"	116 7/16" x 79 1/2"
58 1/2" x 81"	70 1/2" x 81"	82 1/2" x 81"	103 7/16" x 81"	105 5/8" x 81"	140 1/2" x 79 1/2"
59 1/2" x 95 1/2"	71 1/2" x 95 1/2"	94 1/2" x 81"	139 3/8" x 81"	141 5/8" x 81"	114 1/2" x 81"
		95 1/2" x 95 1/2"		9' XOO or OOX door available on demand	138 7/16" x 81"
					140 1/2" x 95 1/2"

ELEMENT

59 1/2" x 79 1/2"	71 1/2" x 79 1/2"	95 1/2" x 79 1/2"	105" x 79 1/2"	107 3/16" x 79 1/2"	116 7/16" x 79 1/2"
58 1/2" x 81"	70 1/2" x 81"	82 1/2" x 81"	103 7/16" x 81"	105 5/8" x 81"	114 1/2" x 81"
59 1/2" x 95 1/2"	71 1/2" x 95 1/2"	94 1/2" x 81"	105" x 95 1/2"	107 3/16" x 95 1/2"	116 7/16" x 95 1/2"
		95 1/2" x 95 1/2"	139 3/8" x 81"	141 5/8" x 81"	140 1/2" x 79 1/2"
				9' XOO or OOX door available on demand	138 7/16" x 81"
					140 1/2" x 95 1/2"

Hardware



Look Handle (Standard)

Zinc or stainless steel double-point mortise option available
Key lock option available

White



View Handle (Option)

Zinc or stainless steel double-point mortise option available
Key lock option available

White
 Oil Rubbed Bronze (paint)
 Satin Nickel

Colors



More than 100 colours available.
Custom colours on demand.

Decorative Options



Dividers

Rectangular 2", 1 x 3 or 1 x 4



Grids

Rectangular 5/8", 3 x 6



Hanging Grids

Rectangular 5/8" ou 1", 3 x 1

Integrated blinds



Integrated blinds are a great way to let light in during the day while ensuring absolute privacy at any moment. Easy to operate with two discreet buttons. Because the blinds are between the glass, they are virtually maintenance free. Available in two colors to match any decor.



White



Satin gray

Security



Double-point mortise lock
(Option shown with Look handle)



Three-position foot lock option
(Option only available in white)



Security bar option
(Option only available in white)

Other Options

Configuration

- Transoms
- Sidelites
- Aluminum sill cover (Standard for Element)
- Inside PVC cavity filler cap (Element — outside aluminium cavity filler cap included)
- Inside / outside PVC cavity filler cap / exterior (550)

Glass options

- Low E glass
- Triple glass
- Tinted grey or bronze glass

Security options



- Reinforced screen

Installation options

- Wood extension on 3 or 4 sides with interior PVC cladding
- PVC Brick mould and aluminum sill extension (550)
- Aluminum brick mould and sill extension (Élément)
- PVC Drywall moulding
- Nail fin

Performance

	550	ELEMENT
Air leakage resistance	A3	A3
Water penetration resistance	B4 / 400 Pa	B4 / 400 Pa
Wind resistance	C3	C3
Operating force	E3	E3
Forced-entry resistance	F2	F2
Uniform load structural test	DP-45	DP-50
Global	PG-R45	PG-R50
Laboratory tested Harmonized standards — AAMA / WDMA / CSA101 / I.S.2 / A440-08 Canadian standards CAN/CGSB-82.1-M89	Reference 71½" × 81" door	Reference 71½" × 81" door

	550		ELEMENT	
	RE	U Value	RE	U Value
Insulated Glass				
Standard Double-pane — Low E on face 3	34	1.70 	32	1.76
Option Double-pane — Low E on face 2	32	1.70	30	1.76
Option Triple-pane — Low E on face 5	38	1.36 	37	1.42 

Warranty



20 years limited warranty on white PVC and Aluminum extrusions and sealed units (Residential applications). 10 years limited warranty for the paint on PVC or Aluminum and on integrated blinds. 5 years limited warranty on hardware. 1 year limited warranty starting on the date of delivery, applied to all manufacturing defects of the product as well as to labor and transportation costs. Consult your retailer for more information.

Novatech®



300 SERIES | ALL PVC - LOW MAINTENANCE

2

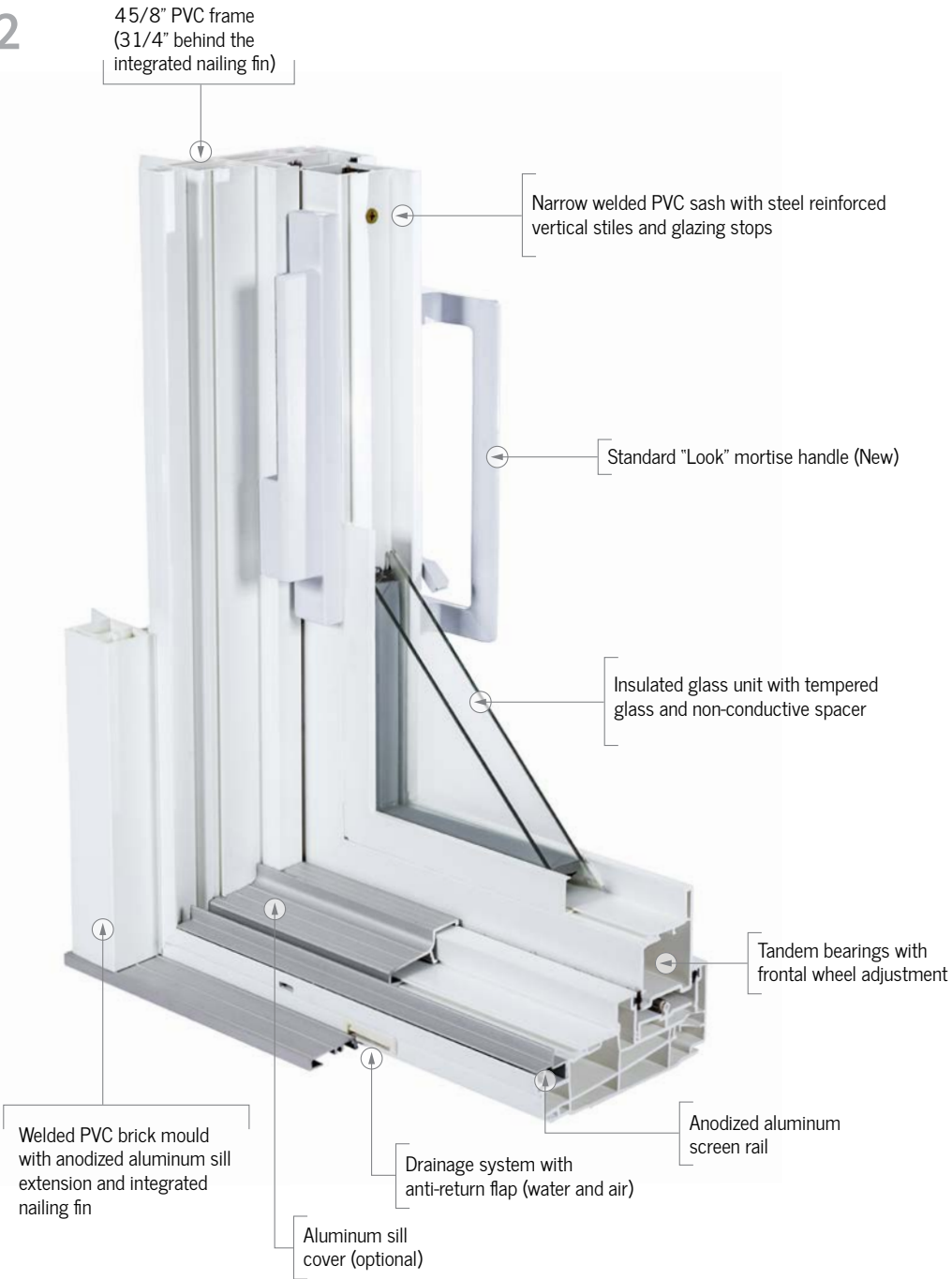

CHOICE OF OPENINGS AND SIZES *Exterior view

X= OPERATING PANEL
O= FIXED PANEL

5'	6'	8'	9' & 12'	9' & 12'	10', 12' & 16'																												
<table border="1"> <tr><td>O</td><td>X</td></tr> <tr><td>X</td><td>O</td></tr> </table>	O	X	X	O	<table border="1"> <tr><td>O</td><td>X</td></tr> <tr><td>X</td><td>O</td></tr> </table>	O	X	X	O	<table border="1"> <tr><td>O</td><td>X</td></tr> <tr><td>X</td><td>O</td></tr> </table>	O	X	X	O	<table border="1"> <tr><td>O</td><td>X</td><td>O</td></tr> <tr><td>X</td><td>O</td><td>O</td></tr> <tr><td>O</td><td>O</td><td>X</td></tr> </table>	O	X	O	X	O	O	O	O	X	<table border="1"> <tr><td>X</td><td>O</td><td>X</td></tr> </table>	X	O	X	<table border="1"> <tr><td>O</td><td>X</td><td>X</td><td>O</td></tr> </table>	O	X	X	O
O	X																																
X	O																																
O	X																																
X	O																																
O	X																																
X	O																																
O	X	O																															
X	O	O																															
O	O	X																															
X	O	X																															
O	X	X	O																														
59 1/2" x 79 1/2" or 95 1/2"	71 1/2" x 79 1/2" or 95 1/2"	95 1/2" x 79 1/2" or 95 1/2"	107" x 79 1/2" or 95 1/2" 143" x 79 1/2" or 95 1/2"	107 1/2" x 79 1/2" or 95 1/2" 143 1/2" x 79 1/2" or 95 1/2"	116 1/2" x 79 1/2" or 95 1/2" 140 5/8" x 79 1/2" or 95 1/2" 188 11/16" x 79 1/2" ou 95 1/2"																												

Sizes up to 16' x 8 (W x H)

ABSOLUTE REFINEMENT. A SURE VALUE
 WELDED PVC FRAME | WELDED PVC PANELS

301

3

ALSO AVAILABLE :
 INTEGRATED ALUMINUM MINI-BLINDS
 OPTIONS - SATIN GREY



PERFORMANCES

Harmonized Standards - 96" x 80"	Air-tightness	Water-tightness	Structure	Overall
AAMA/WDMA/CSA101/IS.2/A440-08	PASSED	360 Pa (470 Pa)	DP-50	PG-R50

Energy efficiency

Double Glazed, Low E 80/70 face #3	ER 34 / U 1.76
Double Glazed, Low E 80/70 face #2	ER 31 / U 1.76
Double Glazed, Low E 62/27 face #2	ER 16 / U 0.29 / SHGC 0.23
Triple Glazed, Low E 80/70 face #5	ER 39 / U 1.36 / SHGC 0.53
Triple Glazed, Low E 80/70 face #2 & #5	ER 40 / U 1.19 / SHGC 0.48

4

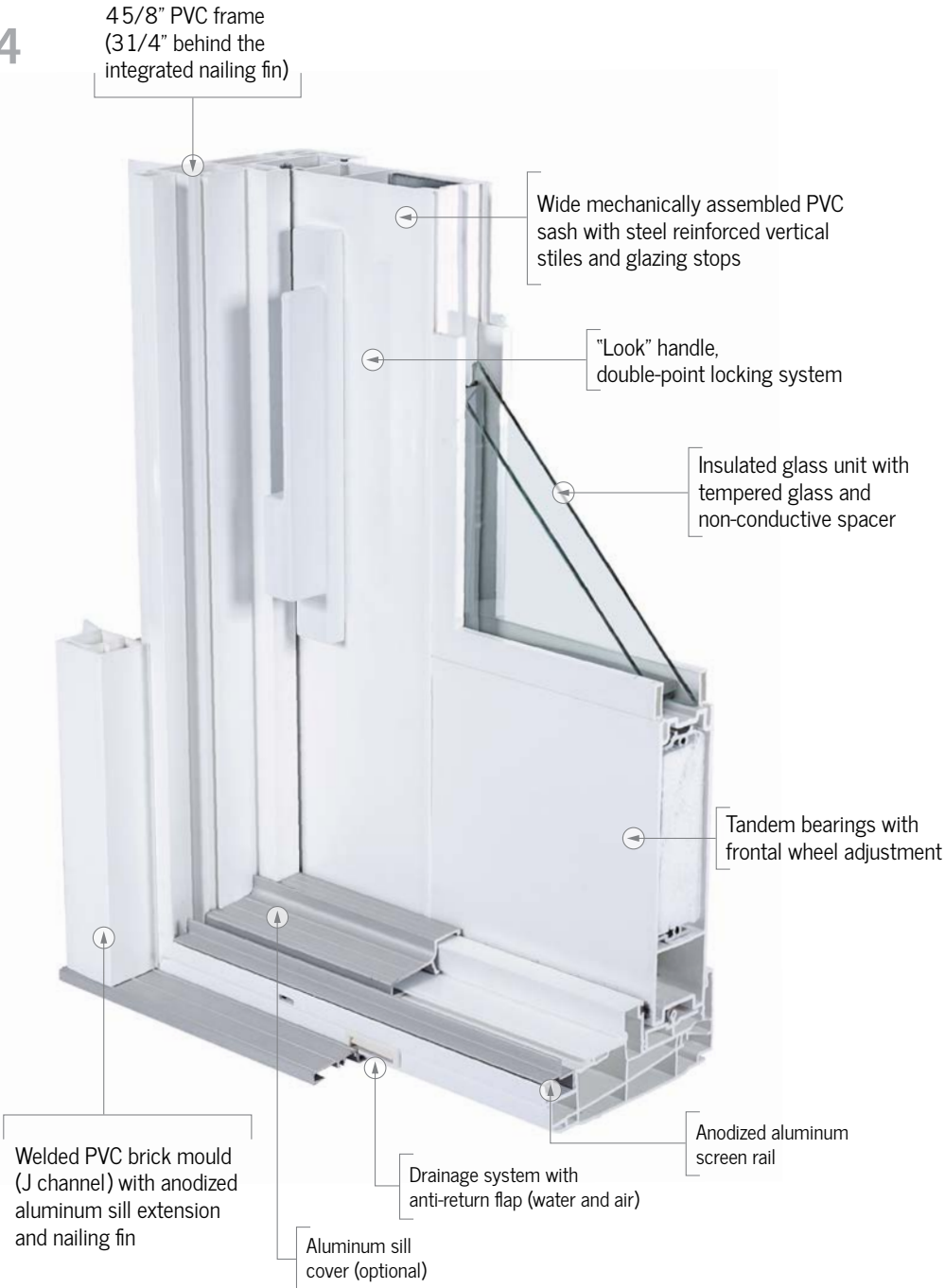

CHOICE OF OPENINGS AND SIZES *Exterior view

X= OPERATING PANEL
O= FIXED PANEL

5'	6'	8'	9' & 12'	9' & 12'	10', 12' & 16'																												
<table border="1"> <tr><td>O</td><td>X</td></tr> <tr><td>X</td><td>O</td></tr> </table>	O	X	X	O	<table border="1"> <tr><td>O</td><td>X</td></tr> <tr><td>X</td><td>O</td></tr> </table>	O	X	X	O	<table border="1"> <tr><td>O</td><td>X</td></tr> <tr><td>X</td><td>O</td></tr> </table>	O	X	X	O	<table border="1"> <tr><td>O</td><td>X</td><td>O</td></tr> <tr><td>X</td><td>O</td><td>O</td></tr> <tr><td>O</td><td>O</td><td>X</td></tr> </table>	O	X	O	X	O	O	O	O	X	<table border="1"> <tr><td>X</td><td>O</td><td>X</td></tr> </table>	X	O	X	<table border="1"> <tr><td>O</td><td>X</td><td>X</td><td>O</td></tr> </table>	O	X	X	O
O	X																																
X	O																																
O	X																																
X	O																																
O	X																																
X	O																																
O	X	O																															
X	O	O																															
O	O	X																															
X	O	X																															
O	X	X	O																														
59 3/8" x 79 1/2" or 95 1/2"	71 3/8" x 79 1/2" or 95 1/2"	95 3/8" x 79 1/2" or 95 1/2"	107 1/2" x 79 1/2" or 95 1/2" 143 1/2" x 79 1/2" or 95 1/2"	107 1/2" x 79 1/2" or 95 1/2" 139 5/8" x 79 1/2" or 95 1/2"	116 3/4" x 79 1/2" or 95 1/2" 140 3/4" x 79 1/2" or 95 1/2" 188 13/16" x 79 1/2" ou 95 1/2"																												

Sizes up to 16' x 8 (W x H)

THE WIDE SASH EVOKES THE CHARM OF A GARDEN DOOR
 WELDED PVC FRAME | MECHANICALLY ASSEMBLED PVC SASHES

370

5



PERFORMANCES

Harmonized Standards - 96" x 80"	Air-tightness	Water-tightness	Structure	Overall
AAMA/WDMA/CSA101/IS.2/A440-08	PASSED	360 Pa	DP-50	PG-R50

Energy efficiency

Double Glazed, Low E 80/70 face #3 ER 27 / U 1.82

Double Glazed, Low E 80/70 face #2 ER 25 / U 1.82

Double Glazed, Low E 62/27 face #2 ER 12 / U 0,31 / SHGC 0.19

Triple Glazed, Low E 80/70 face #5 ER 31 / U 1.53 / SHGC 0.43

Triple Glazed, Low E 80/70 face #2 & #5 ER 32 / U 1.36 / SHGC 0.39

Testing performed in a laboratory

OPTIONS

OFFERED DEPENDING ON THEIR AVAILABILITY FOR EACH MODEL

6

301 WELDED PVC FRAME WELDED PVC PANELS

- Recommended for renovation and new construction, residential projects.
- Thermally welded frame & panels.
- Large glass area and minimal frames in your view.
- Excellent quality and performance ratio.
- All PVC construction with integrated nail fin and easy installation.

370 WELDED PVC FRAME MECHANICALLY ASSEMBLED PVC PANELS

- The 370 combines the practicality of a sliding door with the look of a garden door.
- Thermally welded frame with direct set fixed panel.
- A direct set fixed panel keeps the door square when assembled.
- Excellent quality and performance ratio.
- All PVC construction with integrated nail fin and easy installation.

TRANSOMS AND SIDELITES

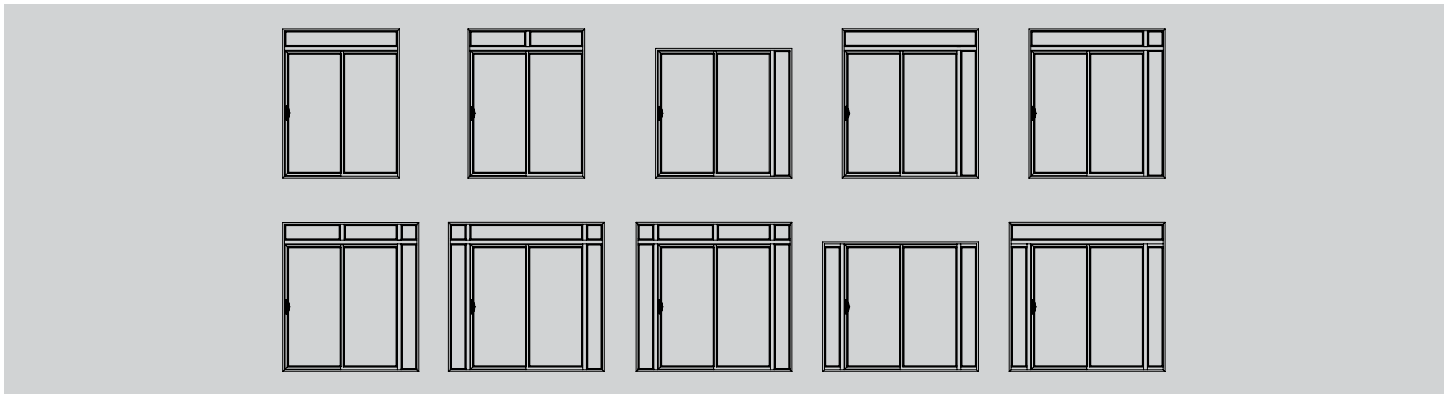

GRIDS



Hanging grids
3 x 1

Perimeter / Prairie grids
3 x 5

Regular grids
3 x 5 or 3 x 6

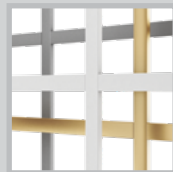

Rectangular / Flat 5/16"



Rectangular / Flat 5/8" or 1"



Georgian / Contoured 5/8" or 1"

OPTIONS CHART

	301	370
Transoms	•	•
Sidelites	•	•
Paint	•	•
Low E glass	STD	STD
Triple glass up to 16' x 8'	•	•
Tinted grey or bronze glass	•	•
Integrated blinds with Low E glass - White	•	—
Integrated blinds with Low E glass - Satin Grey	•	—
Grids	•	•
Brick mould and sill extension	•	•
Nail fin	•	•
Security bar	•	•
Head lock	—	•
Foot lock	•	•
Double-point mortise lock	•	STD
View handle	•	•
Keyed lock	•	•
Reinforced screen	•	•

COLORS

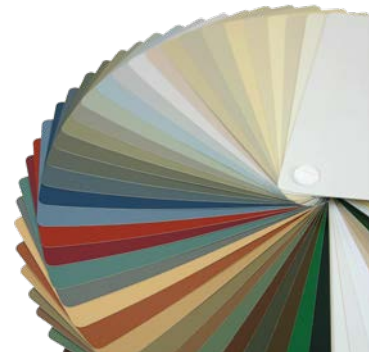

7

HANDLES

LOOK (STANDARD)

VIEW (OPTION)



Available in white, oil rubbed bronze (paint), and satin nickel

Double-point mortise (OPTION)

INTEGRATED BLINDS



Integrated aluminum mini-blinds with Low E glass

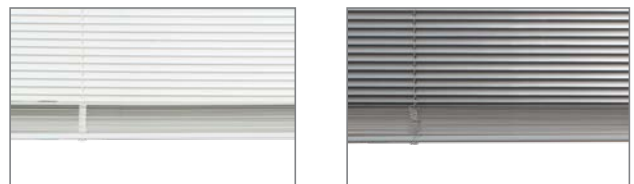

White or Satin grey. Available only in 79 1/2" height.

Please contact your retailer for the availability of these options. Custom configuration possibilities.

Worry-Free Warranty



20 years limited warranty on white PVC and Aluminum extrusions.



20 years limited warranty on sealed units.



10 years limited warranty for the paint on PVC or Aluminum.



5 years limited warranty on hardware.



1 year limited warranty starting on the date of delivery, applied to all manufacturing defects of the product as well as to labor and transportation costs.

Consult your retailer for more information on our Warranty.



grouphenovatech.com

